

V5011P TWO-WAY THREADED GLOBE VALVE

PRODUCT DATA



FEATURES

- Red brass body with BSPT-threaded end connections.
- Low seat leakage rate (≤ 0.05 percent of C_v).
- 50:1 rangeability per VDI/VDE 2173.
- Spring-loaded, self-adjusting packing.
- Accurate positioning to ensure state of the art temperature control.
- Directly coupled electric and pneumatic actuators for easy mounting.
- Sizes range from 1-1/4 in. to 2 in.
- Valve designs provide equal percentage flow characteristic for water and linear flow characteristic for steam.
- Stainless steel stem and metal-to metal seats.
- Repack and rebuild kits for field servicing.

APPLICATION

The V5011P is a two-way threaded globe valve that control steam, water, and glycol solutions (up to 50 percent concentration) in heating or cooling HVAC applications. The valve is used in two-position and modulating control systems. The valve is not suitable for combustible gas service.

SPECIFICATIONS

IMPORTANT

The specifications given in this publication do not include normal manufacturing tolerances. Therefore, an individual unit may not exactly match the listed specifications. Also, this product is tested and calibrated under closely controlled conditions and some minor differences in performance can be expected if those conditions are changed.

Models:

V5011P Valve: Two-way threaded globe valve for steam, water, or glycol. BSPT-threaded pipe connections. Throttling plug provides equal percentage flow characteristic for water (V5011P1xxx), linear flow characteristic for steam (V5011P2xxx).

NOTE: V5011P1xxx and V5011P2xxx are direct acting (stem down to close).

Dimensions: See Fig. 1.

Valve Sizes and Flow Capacities: See Table 1.

Pipe Connections: Internal BSPT-threaded connections.

Seat: Stainless steel, replaceable

Nominal Pressure:

-300 psi cold working pressure (water)
-185 psi steam working pressure

Stem: Stainless steel.

Plug: Brass on V5011P1xxx,
stainless steel on V5011P2xxx for steam.

Stroke: 3/4 in. (20 mm).

Approximate Leakage Rate: 0.05 percent C_v .

Pattern: 2-way, straight-through.

Body Material: Red brass.

Packing: Spring-loaded, carbon fiber reinforced PTFE V-rings.

Rangeability: 50:1 per VDI/VDE 2173.

Pressure-Temperature Ratings:

Water: 2°C to 120°C (36°F to 248°F), 300 psi (20 bar).
120°C to 170°C (248°F to 337°F), 185 psi (12.8 bar).
Steam: 100 psi (6.9 bar) at 337°F (V5011P2xxx).

Maximum Differential for Quiet Water Service: 20 psid.

Valve Flow Characteristics:

Water: Equal percentage (V5011P1xxx).
Steam: Linear (V5011P2xxx). See Fig. 2.

Close-Off Pressure Ratings: See Fig. 3, and Table 2.

Valve Design Life: 250,000 full cycles at maximum rated temperature.

Replacement Parts: See Fig. 5 and Table 3.

Electric	Pneumatic
ML6421/ML6425	MP953C (5 and 8 in.)
ML7421/ML7425	MP953E (5 and 8 in.)
ML7984/ML6984	—
Modutrol IV with Q5001	—
Damper DCA with Q5020	—

Motor and Linkage Selection:

Size (in.)	Capacity (C_v)
1/2	0.73
	1.16
	1.85
	2.9
	4.7
3/4	7.3
1	11.7
1-1/4	18.7
1-1/2	29.3
2	46.8

Table 1. Valve Size and Flow Capacities.

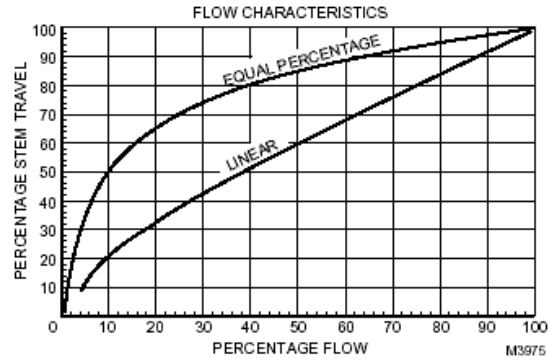
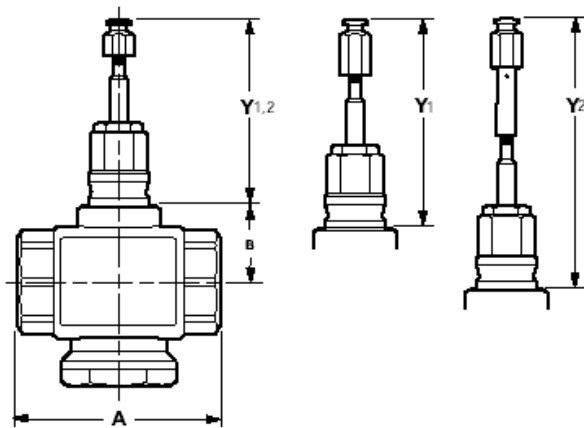

Fig. 2. Equal percentage and linear flow characteristics.

VALVE SIZE (IN)	A in. (mm)	B in. (mm)	VALVE	Y1 in. (mm)	Y2 ^a in. (mm)
1/2	3-1/4 (83)	1-9/16 (40)	V5011P1XXX	3-1/2 (89)	5-1/4 (133)
3/4			OR		
1	4-1/16 (103)		V5011P2XXX	STEM FULLY DOWN	
1-1/4	4-3/16 (106)				
1-1/2	4-3/4 (120)	1-13/16 (47)			
2	5-1/4 (134)				

^aY2 WITH STEM EXTENSION FOR MP953C,E (8 IN. ONLY) MI7378A

Fig. 1. V5011P body dimensions in in. (mm).

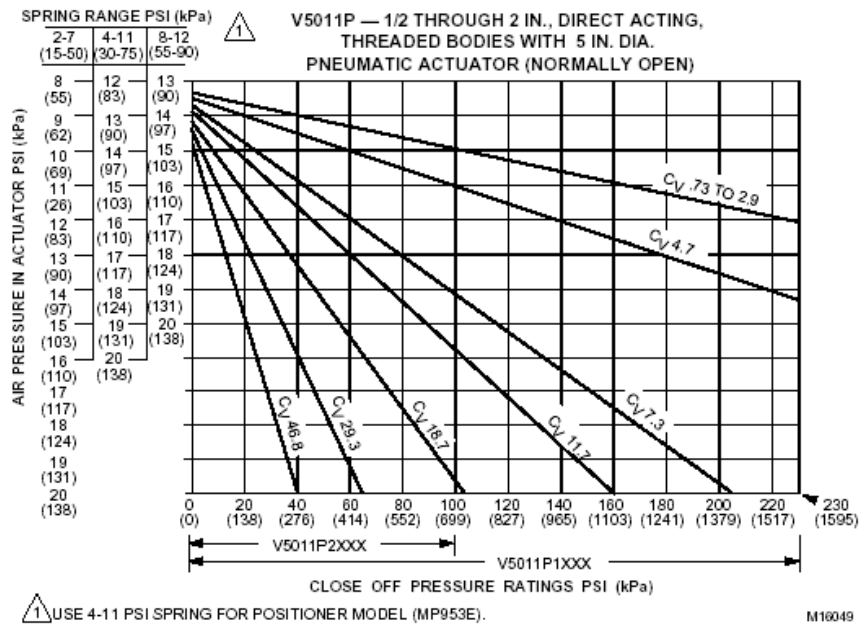

Fig. 3. Close-off ratings at various control air pressures for V5011P Valves and MP953 Pneumatic Actuators.

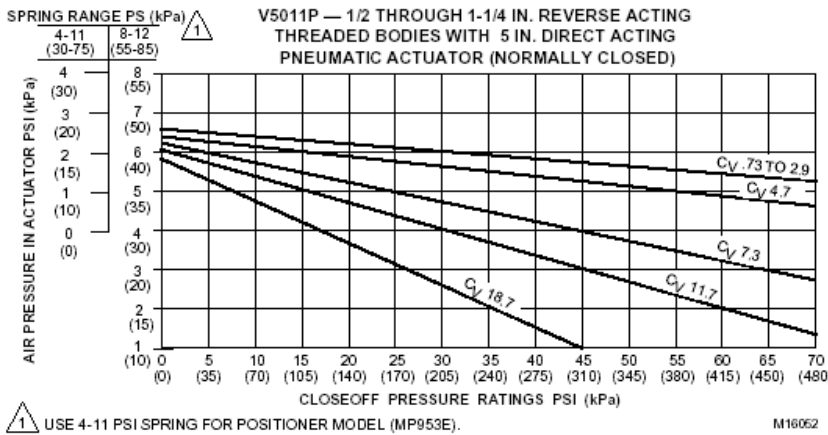
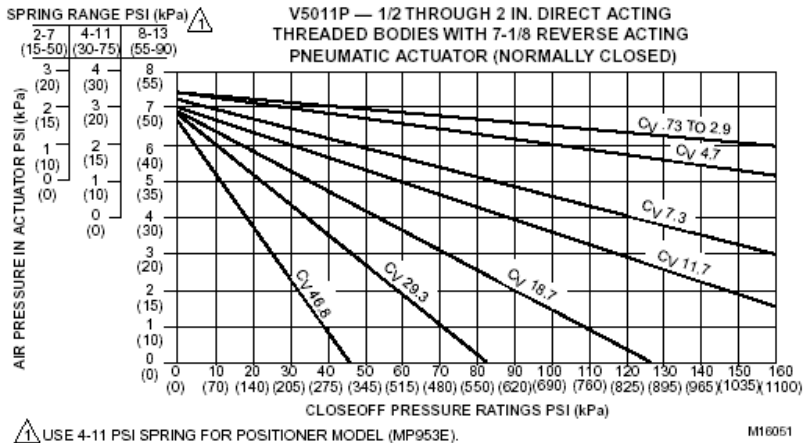
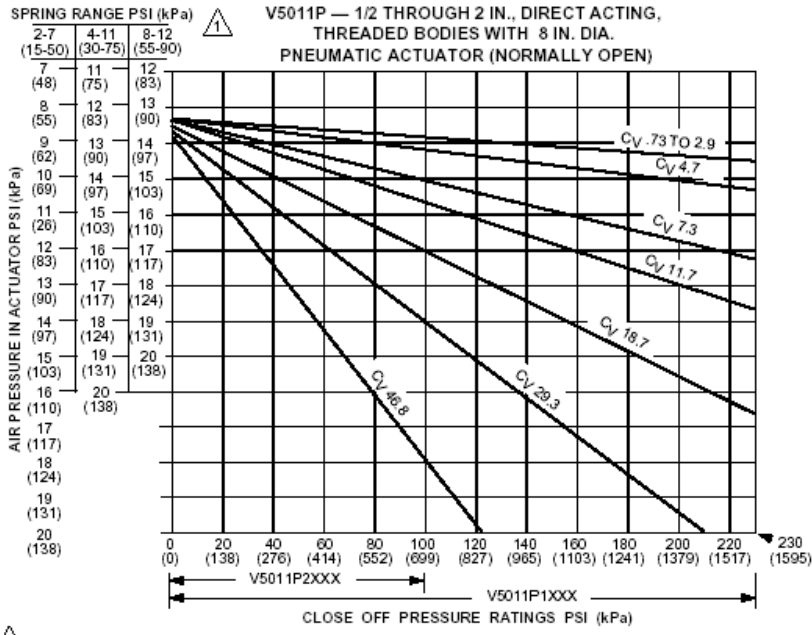

Fig. 3. Close-off ratings at various control air pressures for V5011P Valves and MP953 Pneumatic Actuators. (continued)

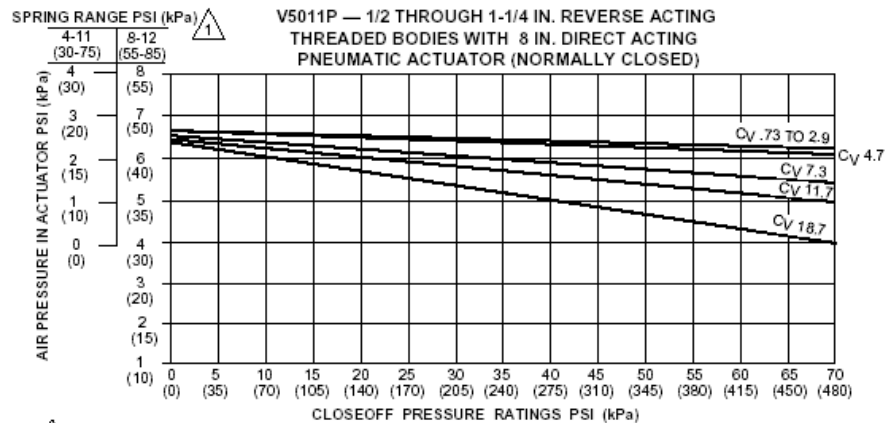
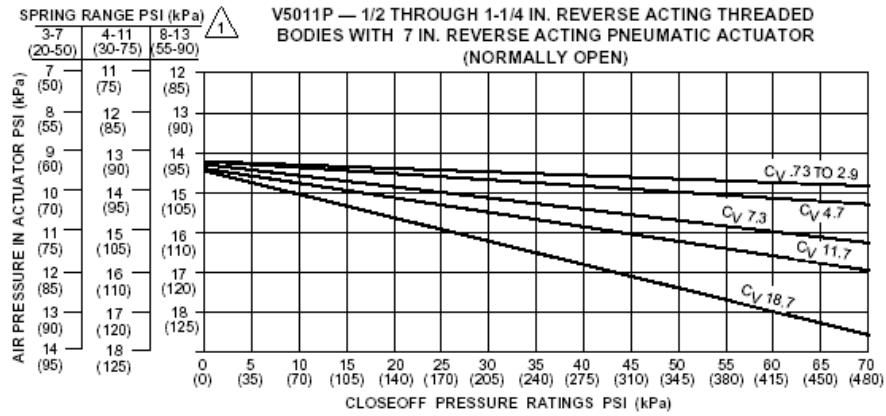

Fig. 3. Close-off ratings at various control air pressures for V5011P Valves and MP953 Pneumatic Actuators. (continued)

INSTALLATION

When Installing This Product.

1. Read these instructions carefully. Failure to follow them could damage the product or cause a hazardous condition.
2. Check the ratings given in the instructions and on the product to make sure the product is suitable for your application.
3. Installer must be a trained, experienced service technician.
4. After installation is complete, check out product operation as provided in these instructions.

IMPORTANT

1. Do not lift the valve by holding the stem.
2. Do not mount the valve with the stem pointed lower than horizontal.
3. Mount the valve with the flow arrow pointed in the direction of flow through the valve.
4. Mount the valve between aligned pipes. Mounting the valve on pipes that are not aligned causes leakage at the valve-to-pipe connection.

5. Ensure complete engagement on pipe to valve body threads.
6. Hold the valve body with a clamp or pipe wrench on the hexagonal fitting nearest the pipe to prevent damage to the valve body while mounting on the pipe. Refer to Fig. 4.
7. Be sure to allow enough room for installation and service. Clearance for valve installation is dependent on actuator size and the valve pipe size.

Location

Select a location where the valve, linkage, and actuator are within the appropriate pressure and temperature ratings. Leave sufficient clearance above the valve to accommodate actuator installation and allow room for servicing the valve body. (Completely install the valve body in the pipe line before installing the actuator and linkage.) When selecting a location for the valve, consider actuator mounting restrictions. Modutrol IV™ Motor crankshafts must be mounted horizontally.

Mounting

The preferred valve mounting position is with the stem vertical. For steam applications, mount with the stem at a 45 degree angle. Do not mount the valve with the stem more than 90 degrees from the vertical (pointing lower than horizontal). Scale and foreign material can collect, scoring the stem and causing packing leakage. Protect the stem from damage due to bending or scratching.

IMPORTANT

1. Before installing linkage and actuator, make sure that the valve stem operates freely. Impaired stem operation can indicate that the body was twisted or the stem was bent. Either of these conditions can require valve replacement.
2. Align pipes squarely with valve at each end connections.

3. If the pipes are forced into the valve, the body can become twisted and improper seating can result.
4. Apply pipe dope sparingly.
5. Be careful to prevent pipe debris, such as chips and scale, from entering the piping because this material can lodge in the seat and prevent proper closing.

NOTE: Threading on threaded bodies conform to BSPT.

Refer to the table in Fig. 4 for valve pipe sizes and thread lengths. Fig. 4 also shows two effective methods of holding the valve and pipe when attaching it. Refer to installation information furnished with the linkage and motor when installing these controls.

Table 2. Close-off Ratings (psid) for V5011P Valves with Electric/Electronic Actuators.

Valve Size (BSPT)	Mod IV Motor with Q5001 Linkages			ML6421A, ML7421A	ML6425, ML7425 ML6420, ML7420	ML7984, ML6874
	320 lb	160 lb	80 lb	405 lb	135 lb	160 lb
V5011P1xxx						
1/2	—	230 ^a	230 ^a	—	230 ^a	230 ^a
3/4	—	230 ^a	131			
1	230 ^a	196	91	230 ^a	163	196
1-1/4	230 ^a	126	57	230 ^a	104	126
1-1/2	173	81	36	221	67	81
2	98	46	19	126	37	46
V5011P2xxx Valves						
1/2, 3/4	—	100 ^a	100 ^a	—	100 ^a	100 ^a
1	100 ^a	100 ^a	91	100 ^a		
1-1/4	100 ^a	100 ^a	57			
1-1/2	100 ^a	81	36	100 ^a	67	81
2	98	46	19	100 ^a	37	46

^aPressure is limited by fluid temperature. See valve temperature/pressure ratings.

Fig. 4. Installing valves with threaded connections.

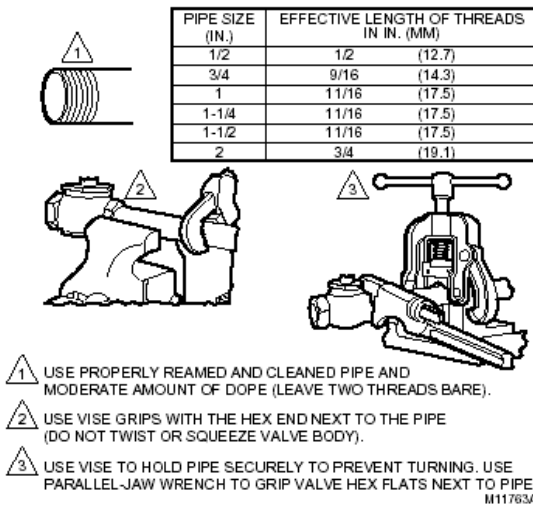

CHECKOUT

Use the following procedure to check for proper valve operation:

1. Check valve body and connections for leaks.
2. After installing linkage and actuator, check operation according to installation information furnished with these controls.
3. Operate system through one complete cycle to ensure valve controls properly.
4. Check valve at regular intervals for leakage around packing.

IMPORTANT

Before installing linkage (if used) and actuator, make sure that the valve stem operates freely. Impaired stem operation can indicate that the body was twisted or the stem was bent. Either of these conditions can require valve replacement.

NOTE: Packing is spring-loaded and should seldom require attention.

5. If leakage is discovered and inspection shows that the packing gland is screwed down tightly, then repack the valves.

Table 3. Valve Rebuild and Repack Kits.

Order Number	BSPT size	Flow Capacity C _v	Stem Diameter (in.)	Repack Kit	Rebuild Kit
V5011P1004	DN25	11.7	3/8	0901787A	0901752A
V5011P1012	DN32	18.7			0901753A
V5011P1020	DN40	29.3			0901754A
V5011P1038	DN50	46.8			0901755A
V5011P2002	DN32	18.7		0901787A	0903429A
V5011P2010	DN40	29.3			0903430A
V5011P2028	DN50	46.8			0903431A

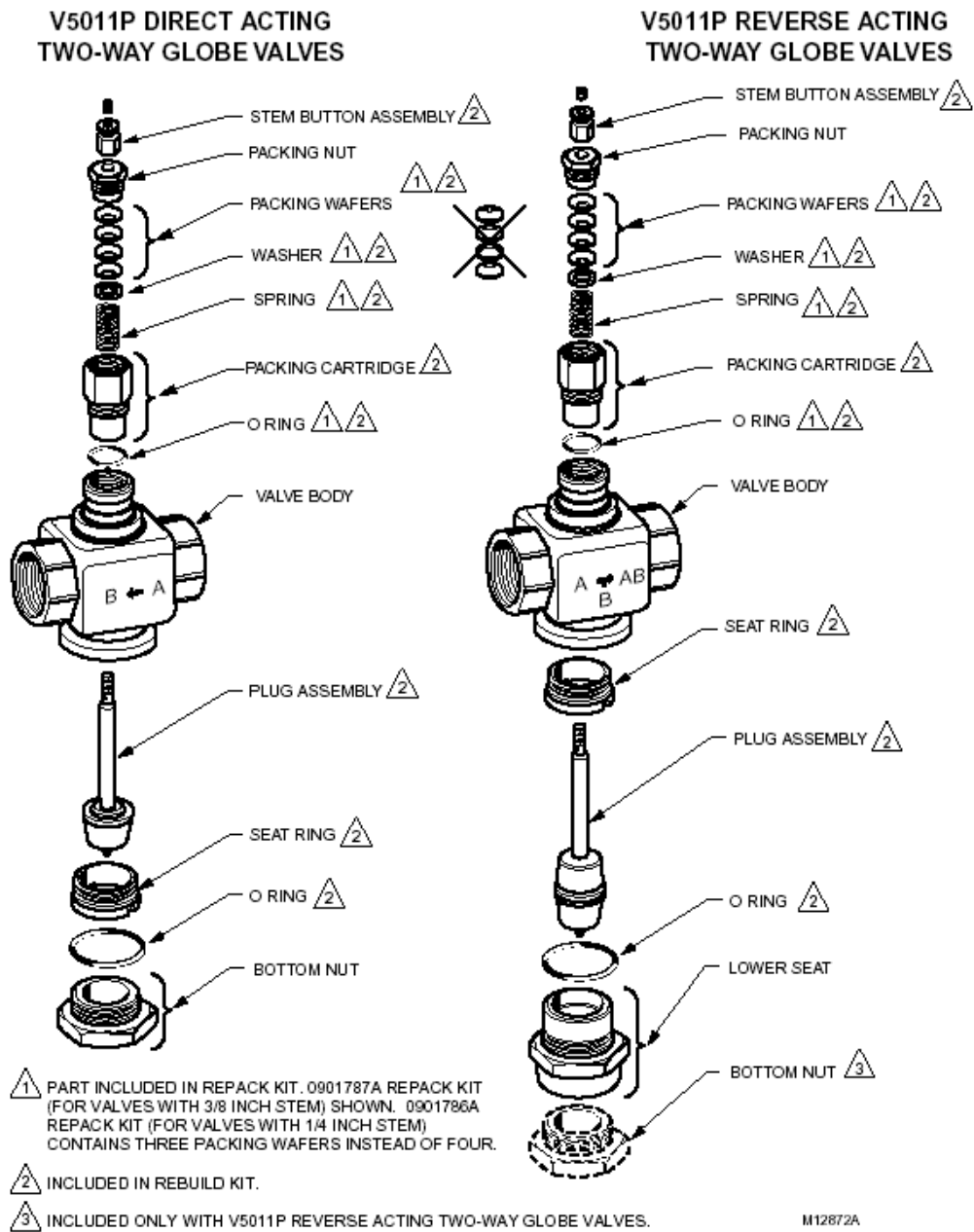

Fig. 5. V5011P replacement parts.

Honeywell

Automation and Control Solutions
 Honeywell Taiwan Ltd.
 10F, 168 Lien Cheng Road
 Chung Ho City, Taipei County, Taiwan
 Phone: +886-2-2245 1000
 Fax: +886-2-2245 3241

Subject to change without notice. Printed in Taiwan