



ACVATIX™

## Electromotoric rotary actuators for butterfly or slipper valves

**SAL..**

with 90° rotary angle

- 
- SAL31.. Operating voltage AC 230 V, 3-position control signal
  - SAL61.. Operating voltage AC/DC 24 V, control signal 0...10 V,  
4...20 mA, 0...1000 Ω
  - SAL81.. Operating voltage AC/DC 24 V, 3-position control signal
  - SAL61.. Position feedback, override control
  - For direct mounting on butterfly or slipper valves; no adjustments required
  - Manual adjuster, position indicator and status indication with LED
  - Optional functions with auxiliary switches, potentiometer

### Use

---

For the operation of Siemens butterfly and slipper valves, types VKF41..., VKF46..., and VBF21.. as control or shutoff valves in heating, ventilation and air conditioning systems.

## Type summary

Product no.	Stock no.	Angular rotation	Torque	Operating voltage	Positioning signal	Positioning time	LED	Manual adjuster	Extra functions	
SAL31.00T10	S55162-A108	90°	10 Nm	AC 230 V	3-position	120 s	-	Push and fix	-	
SAL31.00T20	S55162-A110		20 Nm							
SAL31.00T40	S55162-A111		40 Nm							
SAL31.03T10	S55162-A109		10 Nm	AC/DC 24 V	DC 0...10 V DC 4...20 mA 0...1000 Ω	30 s	✓			Position feed-back, forced control
SAL61.00T10	S55162-A100		20 Nm							
SAL61.00T20	S55162-A102		40 Nm							
SAL61.00T40	S55162-A103		40 Nm	10 Nm	3-position	120 s	-	-		
SAL61.03T10	S55162-A101		20 Nm							
SAL81.00T10	S55162-A104		40 Nm							
SAL81.00T20	S55162-A106		20 Nm	10 Nm	3-position	120 s	-	-		
SAL81.00T40	S55162-A107		40 Nm							
SAL81.03T10	S55162-A105		10 Nm			30 s				

## Electrical accessories

Product no.	Auxiliary switch ASC10.51	Potentiometer ASZ7.5/.. <sup>1)</sup>
Stock no.	S55845-Z103	S55845-Z104 (ASZ7.5/135) S55845-Z105 (ASZ7.5/200) S55845-Z106 (ASZ7.5/1000)
Max. 2 in total		
SAL31..	Max. 2	Max. 1
SAL61..	Max. 2	-
SAL81..		Max. 1

<sup>1)</sup> Available with 135 Ω, 200 Ω or 1000 Ω

## Mechanical accessories

Product no.	Weather shield ASK39.1	Mounting set		
		ASK31N for VBF21..	ASK33N for VKF41..	ASK35N for VKF45.. <sup>1)</sup>
Stock no.	S55845-Z109	S55845-Z100	S55845-Z101	S55845-Z102
SAL..T10	Max. 1	✓	✓	-
SAL..T20		-	-	DN40...DN65
SAL..T40		-	DN150...DN200	DN80...DN200

<sup>1)</sup> Type VKF45.. was replaced by type VKF46.. in the year 2000

## Ordering



### Example

Product no.	Stock no.	Description	Quantity
SAL31.00T10	S55162-A108	Rotary actuator	1
ASZ7.5/1000	S55845-Z106	Potentiometer	1



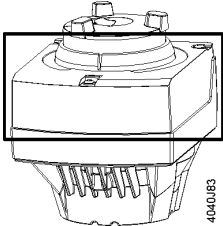

### Delivery

Actuators, valves and accessories are supplied in individual packs.

### Spare parts

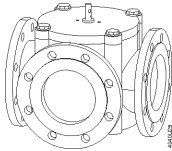
Stock number 8000060844	Housing cover 	
	2 adapters  1 pc. 14 mm 1 pc. 11 mm	
	4 screws  2 pcs. M5 x 20 mm 2 pcs. M6 x 20 mm	

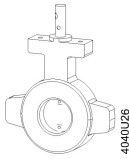
## Combinations

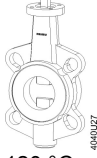
SAL..				Angular rotation Torque	SAL..T10	SAL..T20	SAL..T40	
					10 Nm	90 ° 20 Nm	40 Nm	
<b>Slipper valves</b>	<b>Data Sheet</b>	<b>Valve type <sup>1)</sup></b>	<b>DN</b>	<b>k<sub>vs</sub> [m<sup>3</sup>/h]</b>	<b>Mounting set</b>	<b>Δp<sub>max</sub> [kPa]</b>		
<b>PN6</b>   1 °C... 120 °C	N4241	<b>VBF21.40</b>	40	25	-	30	-	
		<b>VBF21.50</b>	50	40	-			
		<b>VBF21.65</b>	65	63	ASK31N			
		<b>VBF21.80</b>	80	100	ASK31N			
		<b>VBF21.100</b>	100	160	ASK31N			
		<b>VBF21.125</b>	125	550	ASK31N			
		<b>VBF21.150</b>	150	820	ASK31N			
<b>Butterfly valves</b>						<b>Δp<sub>s</sub> [kPa]</b>		
<b>PN16</b>   -10 °C... 120 °C	N4131	<b>VKF41.40</b>	40	50	ASK33N	500	-	
		<b>VKF41.50</b>	50	80	ASK33N			
		<b>VKF41.65</b>	65	200	ASK33N			
		<b>VKF41.80</b>	80	400	ASK33N			
		<b>VKF41.100</b>	100	760	ASK33N			
		<b>VKF41.125</b>	125	1'000	ASK33N			300
		<b>VKF41.150</b>	150	2'100	ASK33N			250
<b>VKF41.200</b>	200	4'000	ASK33N	125	-	300		
<b>PN16</b>   -10 °C... 120 °C	N4136	<b>VKF46.40</b>	40	50	-	-	1'600	
		<b>VKF46.50</b>	50	85	-			
		<b>VKF46.65</b>	65	215	-			
		<b>VKF46.80</b>	80	420	-			
		<b>VKF46.100</b>	100	800	-			1600
		<b>VKF46.125</b>	125	1'010	-			1200
							800	

- 1) SAL..T10 rotary actuators only fit on VBF21..., DN65...150. For VBF21..., DN40/50 use SQK34..., SQK84... (data sheet N4508) or SQK33.00 (data sheet N4506) rotary actuators.

## Product documentation

Detailed information about the New Generation actuators can be found in the basic documentation "Electromotoric actuators SAX..., SAL.." (CE1P4040en).

## Notes

### Engineering

SAL 31.. / SAL81..

3-position actuators must have their own specific controller, refer to "Connection Diagrams" (page 8).

SAL61..

Up to 10 actuators can drive in parallel on a controller output with a rating of 1 mA. Modulating actuators have an input impedance of 100 kΩ.

## Mounting

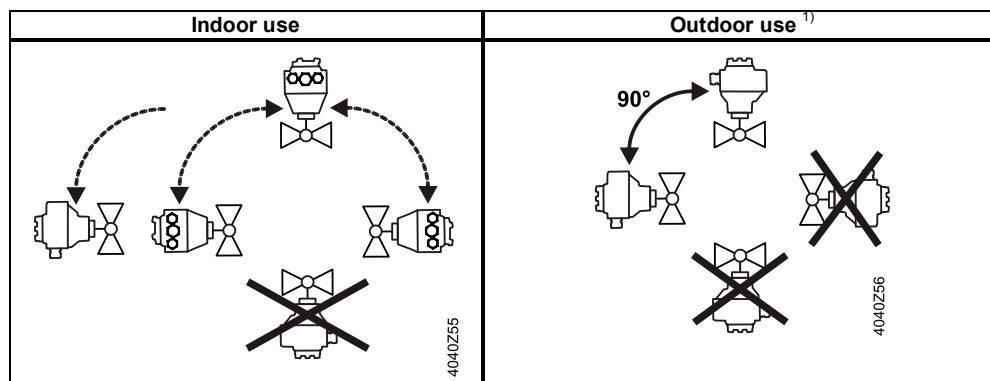

<sup>1)</sup> Only in connection with weather shield ASK39.1

## Maintenance

The rotary actuators are maintenance-free.

## Warranty

The engineering data specified in chapter "Combinations" (page 3) are only guaranteed in connection with the Siemens valves listed.

## Note

**When using the actuators in connection with slipper valves of other manufacture, correct functioning must be ensured by the user, and Siemens will assume no responsibility. The use of the rotary actuators SAL..T10 with butterfly valves is only permitted for the Siemens Series VKF41..**

## Technical Data

		SAL..
<b>Power supply</b>	Operating voltage SA..31.. SA..61.. SA..81..	AC 230 V ±15% AC 24 V ± 20% / DC 24 V + 20% / -15% AC 24 V ±20% / DC 24 V + 20 % / -15%
	Frequency	45...65 Hz
	Fusing ac. DIN 57 100 part 430 (supply lines)	6 A...10 A slow
	Power consumption at 50 Hz	
	SAL31.00T10 Rotary actuator turns	3.5 VA / 2 W
	SAL31.00T20 Rotary actuator turns	4.5 VA / 2.75 W
SAL31.00T40 Rotary actuator turns	7 VA / 4 W	
SAL31.03T10 Rotary actuator turns	5,5 VA / 3.25 W	
SAL61.00T10 Rotary actuator turns	5 VA / 2.5 W	
SAL61.00T20 Rotary actuator turns	6 VA / 2.75 W	
SAL61.00T40 Rotary actuator turns	9 VA / 4 W	
SAL61.03T10 Rotary actuator turns	7.5 VA / 3.5 W	
SAL81.00T10 Rotary actuator turns	3 VA / 2 W	
SAL81.00T20 Rotary actuator turns	4 VA / 2.75 W	
SAL81.00T40 Rotary actuator turns	6 VA / 3.75 W	
SAL81.03T10 Rotary actuator turns	5 VA / 3.5 W	
<b>Function data</b>	Positioning times (with spec. nominal angular rotation)	
	SAL31.00.., SAL61.00.., SAL81.00	120 s
	SAL31.03T10, SAL61.03T10 SAL81.03T10	30 s
	Torque	SAL..T10 10 Nm running / min. 4 Nm holding SAL..T20 20 Nm running / min. 14 Nm holding SAL..T40 40 Nm running / min. 14 Nm holding
	Rotary angle	90°
Permissible medium temperature (valve fitted)	-10...120 °C	
<b>Signal inputs</b>	Positioning signal "Y"	3-position
	SAL31.., SAL81..	
	SAL31.. Voltage	AC 230 V ±15%
	SAL81.. Voltage	AC 24 V ± 20 % / DC 24 V + 20 % / -15%
	SAL61.. (DC 0...10 V) Current draw	≤ 0.1 mA
	Input impedance	≥100 kΩ
SAL61.. (DC 4...20 mA) Current draw	DC 4...20 mA ± 1%	
Input impedance	≤500 Ω	

		SAL..
<b>Parallel operation</b>	SAL61..	≤ 10 (depending on controller output)
<b>Forced control</b>	Positioning signal "Z" SAL61.. R = 0...1000 Z connected to G Z connected to G0 Voltage Current draw	R = 0...1000 Ω, G, G0 Stroke / rotation proportional to R 90° <sup>1)</sup> 0° <sup>1)</sup> Max. AC 24 V ± 20% Max. DC 24 V + 20% / -15% ≤ 0.1 mA
<b>Position feedback</b>	Position feedback U SAL61.. Load impedance Load	DC 0...10 V ± 1% >10 kΩ res. Max. 1 mA
<b>Connecting cable</b>	Wire cross-sectional areas	0.75...1.5 mm <sup>2</sup> , AWG 20...16 <sup>2)</sup>
Connecting cable	Cable entries	2 entries ∅ 20.5 mm (for M20) 1 entry ∅ 25.5 mm (for M25)
<b>Degree of protection</b>	Housing from vertical to horizontal	IP54 as per EN 60529 <sup>3)</sup>
	Insulation class SAL31.. AC 230 V SAL61.. AC / DC 24 V SAL81.. AC / DC 24 V	As per EN 60730 II III III
<b>Environmental conditions</b>	Operation  Climatic conditions Mounting location Temperature Humidity (noncondensing)	IEC 60721-3-3  Class 3K5 Indoors (weather-protected) -15...55 °C 5...95 % r.h.
	Transport  Climatic conditions Temperature Humidity	IEC 60721-3-2 Class 2K3 -25...70 °C <95 % r.h.
	Storage  Climatic conditions Temperature Humidity	IEC 60721-3-1 Class 1K3 -15...55 °C 5...95 % r.h.
	Max. media temperature when mounted on valve	120 °C
<b>Standards</b>	CE conformity As per EMC directive Immunity Emmissions	2004/108/EC EN 61000-6-2:[2005] Industrial <sup>4)</sup> EN 61000-6-3:[2007] Residential
	Electrical safety	EN 60730-1
	Low-voltage directive AC 230	2006/95/EC
		C-tick N 474
	UL conformity AC 230 V ( SAL3..) AC/DC 24 V ( SAL 6., SAL8..)	none UL 873
<b>Environmental compatibility</b>	-	ISO 14001 (environment) ISO 9001 (quality) SN 36350 (environment-compatible products) RL 2002/95/EG (RoHS)
<b>Dimensions</b>	-	See "Dimensions" (page 9)
<b>Weight</b>	Excl. packaging	See "Dimensions" (page 9)
<b>Accessories</b>	Potentiometer ASZ7.5/135  Voltage Current rating	0...135 Ω ± 5% DC 10 V <4 mA
	Potentiometer ASZ7.5/200  Voltage Current rating	0...200 Ω ± 5% DC 10 V <4 mA
	Potentiometer ASZ7.5/1000  Voltage Current rating	0...1000 Ω ± 5% DC 10 V <4 mA
	Auxiliary switch ASC10.51 Switching capacity	AC 24...230 V, 6 A res., 3 A ind.

<sup>1)</sup> Observe acting direction of DIL switches

<sup>2)</sup> AWG = American wire gauge

<sup>3)</sup> Also with weather shield ASK39.1

<sup>4)</sup> Transformer 160 VA (e.g. Siemens 4AM 3842-4TN00-0EA0) for actuators operating on AC 24 V

Connection Diagrams

Internal Diagrams

SAL31..

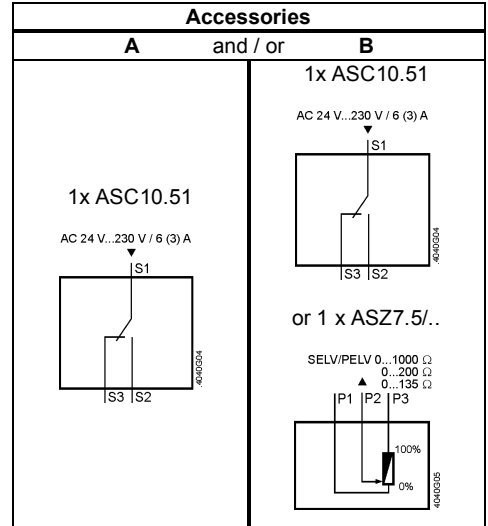
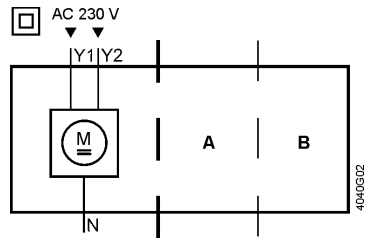

SAL61..

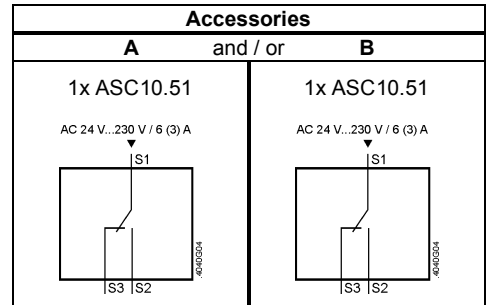
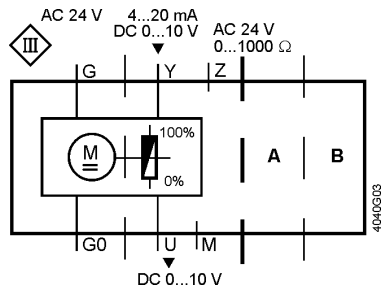

SAL81..

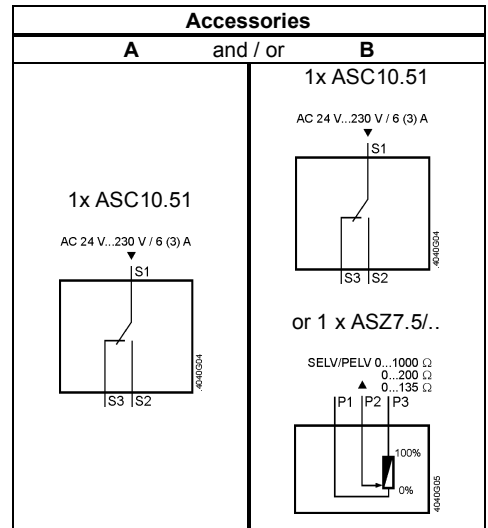
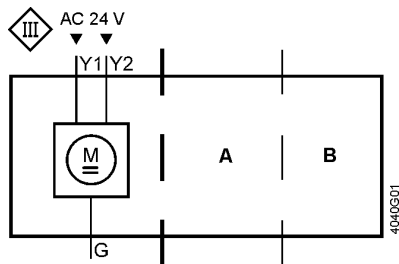

## Connection terminals

SAL31..

AC 230 V, 3-position

- |    |   |   |
|----|---|---|
| N  | — | System neutral (SN)   |
| Y1 | — | Positioning signal (actuator's spindle turns clockwise)         |
| Y2 | — | Positioning signal (actuator's spindle turns counter-clockwise) |

SAL61..

AC/DC 24 V, DC 0...10 V / 4...20 mA / 0...1000 Ω

- |    |   |  |
|----|---|--|
| G0 | — | System neutral (SN)  |
| G  | — | System potential (SP)  |
| Y  | — | Positioning signal for DC 0...10 V / 4...20 mA                               |
| M  | — | Measuring neutral  |
| U  | — | Position feedback DC 0...10 V – (reference potential is M measuring neutral) |
| Z  | — | Positioning signal forced control AC/DC ≤ 24 V, 0...1000 Ω                   |

SAL81..

AC/DC 24 V, 3-position

- |    |   |   |
|----|---|---|
| G  | — | System potential (SP)   |
| Y1 | — | Positioning signal (actuator's spindle turns clockwise)         |
| Y2 | — | Positioning signal (actuator's spindle turns counter-clockwise) |

## Connection terminals accessories

Auxiliary switch  
ASC10.51

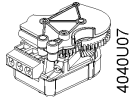

Adjustable switching points, AC 24...230 V

- |   |   |  |
|---|---|--|
| 1 | — | System potential (SP)                        |
| 2 | — | Closing (actuator's spindle turns clockwise) |
| 3 | — | Opening (actuator's spindle turns clockwise) |

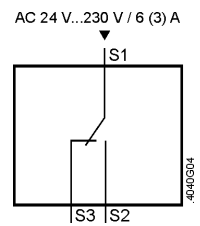

Potentiometer  
ASZ7.5/..

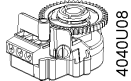

Adjustment of zero point, DC 10 V

- |   |   |                   |
|---|---|-------------------|
| 1 | — | Measuring neutral |
| 2 | — | 0...x Ω           |
| 3 | — | x...0 Ω           |
- x = 135 Ω, 200 Ω; 1000 Ω

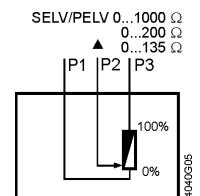

## Connection Diagrams

SAL31..

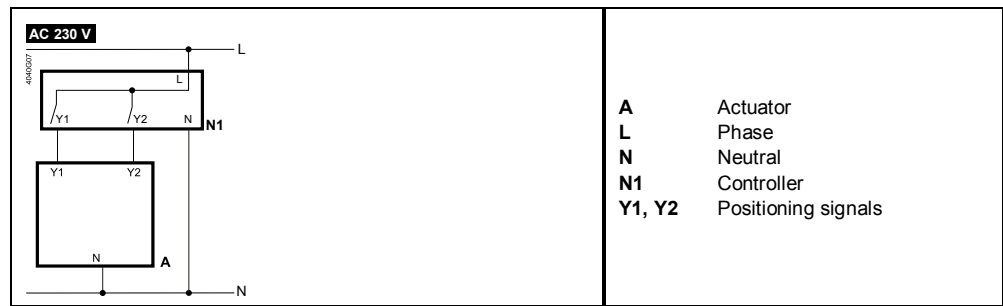

SAL61..

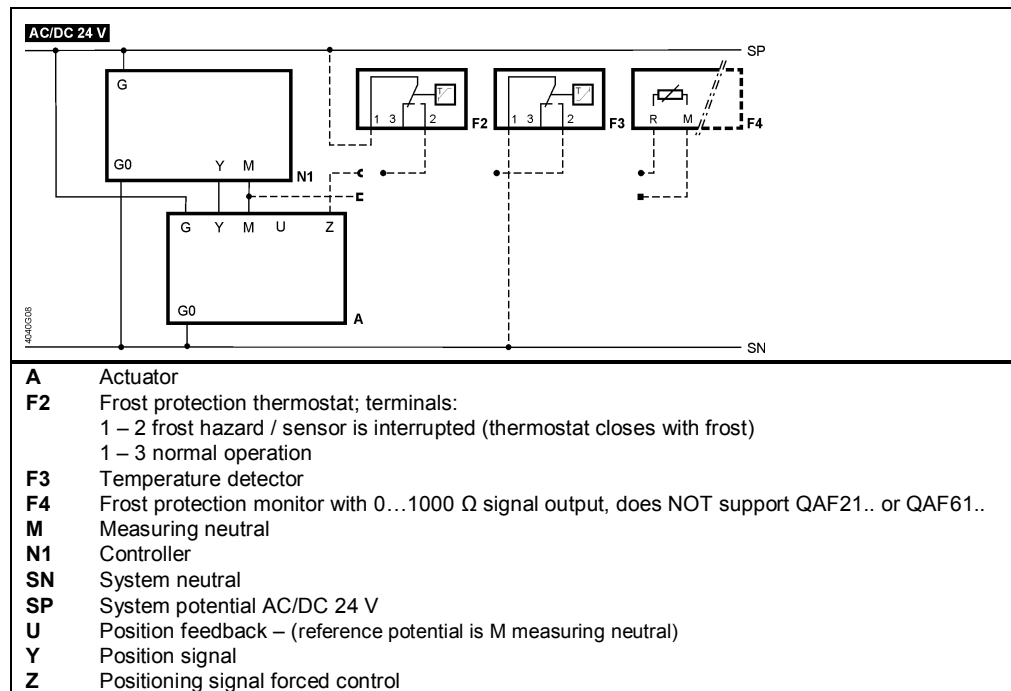

SAL81..

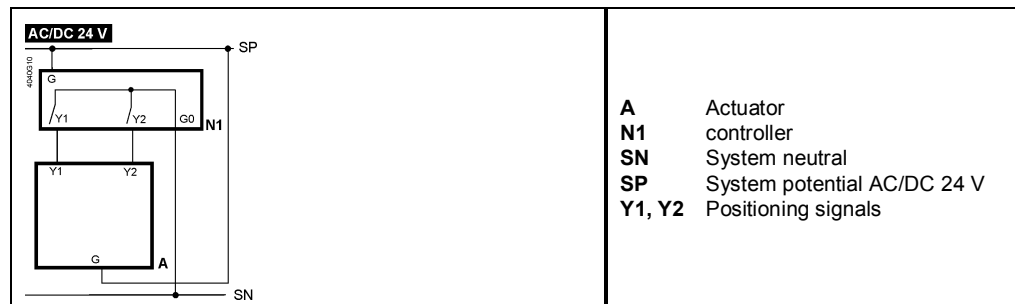



## Dimensions

Dimensions in mm

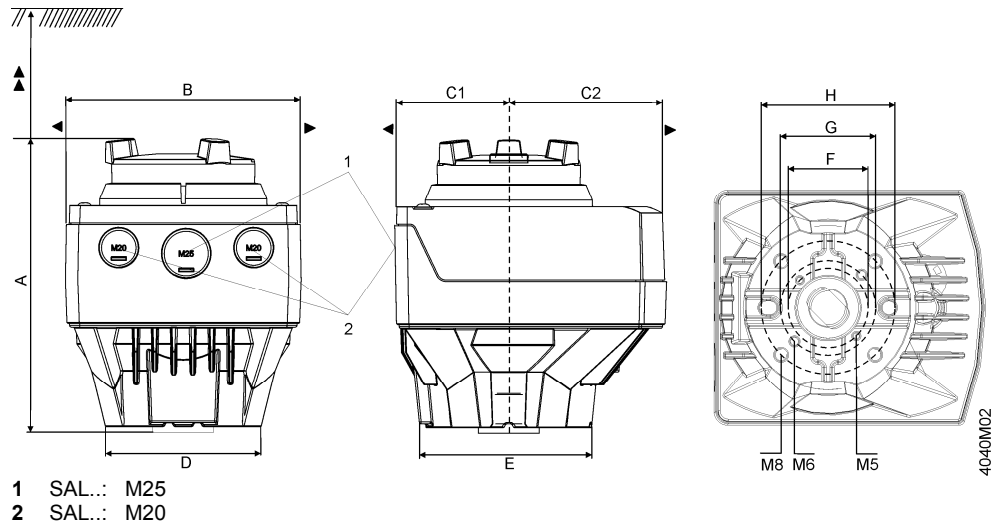

Type	A	B	C	C1	C2	D	E	F	G	H	▶	▶▶	kg		
													SAL..T10	SAL..T20	SAL..T40
SAL..	160	124	150	68	82	82	88	42	50	70	100	200	1.475	1.600	1.625
With ASK39.1	+25	154	300	200	100	-	-	-	-	-	-	-	1.710	1.835	1.860

### With mounting set ASK3..N

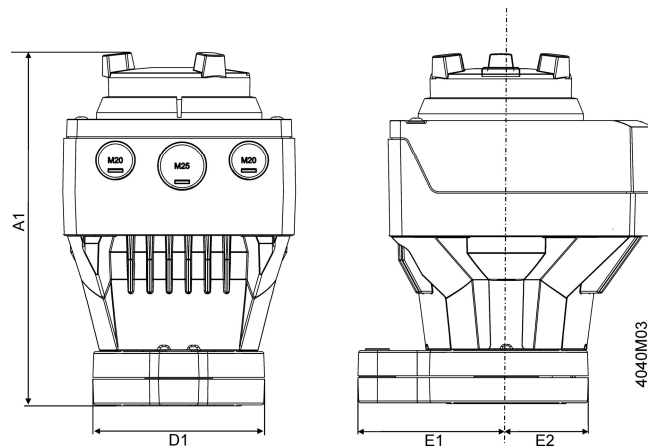

Type	A1	D1	E1	E2
SAL.. with ASK3..N	188	88	80	44
With ASK39.1	+25	-	-	-

### Revision numbers

Product no.	Valid from rev. no.
SAL31.00T10	..D
SAL31.00T20	..C
SAL31.00T40	..A
SAL31.03T10	..D
SAL61.00T10	..D
SAL61.00T20	..C
SAL61.00T40	..A
SAL61.03T10	..D
SAL81.00T10	..D
SAL81.00T20	..C
SAL81.00T40	..A
SAL81.03T10	..D

